

Tomas and Jan Bata and Competitive Business Strategies for Present Business World

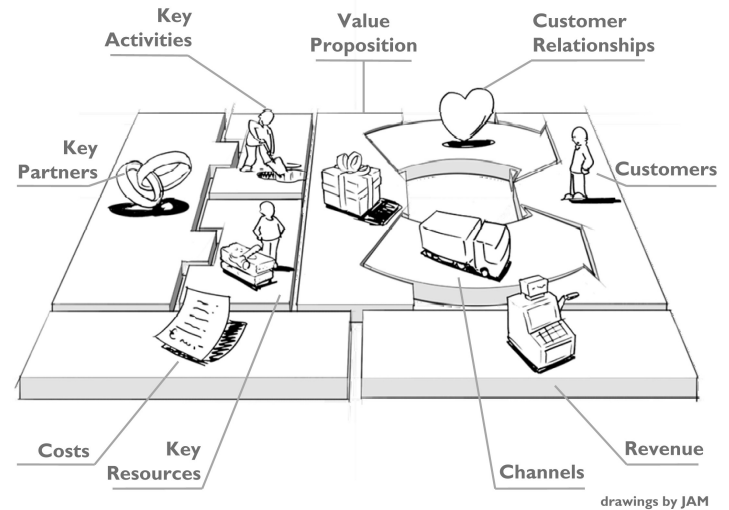

Bata



Ján Košturiak

Introduction – inspired by Bat'a



Dobry Pastier





Tomas and Jan Antonin Bata both had to manage their global enterprises under the conditions of local, European and world crises of the 20s and 30s. Yet, they prospered and during the worldwide depression of the 30s they achieved unprecedented global growth and flourish.

1894–1932 = 38 years Tomáš Baťa (1876–1932)

- 35 lines of business in the industry, transport and service sectors
- 31,000 employees in the Czechoslovak Republic and abroad
- factories and subsidiaries in 25 countries
- network of 2,500 Bata shoe stores ranging from Chicago to Singapore
- annual production of 36,300,000 pairs of shoes (1932)



Mayor of Zlín (1923–1932)

1932–1939 = 7 years Jan A. Baťa + Dominik Čipera + Hugo Vavrečka

- 40 lines of business in the industry, transport and service sectors
- 65,000 employees in the Czechoslovak Republic and abroad (1938)
- factories and subsidiaries in 39 countries
- network of 5,500 Bata shoe stores
- annual production of over 58,000,000 pairs of shoes (1936)

"Many people claim that is impossible to build large corporations in our country because we lack the sea, the coal, and oil resources available in America. I am convinced that the prosperity of the American people is based primarily on the wisdom and diligence of their population... I would like to prove that such enterprises can be created in our country as well." (*Sdělení*, 25. 8. 1923)



J. A. Baťa (1898–1965)



D. Čipera (1893–1963)

Mayor of Zlín (1932–1945)
Minister of Public Works (1938–1942)



H. Vavrečka (1880–1952)

Minister (1938)

World War II 1939–1945

Continental Europe (Zlín)
1939–1945 D. Čipera + H. Vavrečka + J. Hlavnička

□ about 85,000 employees (around 1943)

United Kingdom and overseas
1939–1941 J. A. Baťa
1941–1945 T. J. Baťa Jr.

□ about 30,000 employees (around 1945)

1945–2001 = 56 years

Tomáš J. Baťa Jr. / Thomas J. Bata (1914–2008)

After the nationalization of companies in Central and South-Eastern Europe (1945), he managed the Bata companies in the democratic world (Western Bata Organisation)

1945 London (Bata Development Limited)

1964 Toronto (Bata Shoe Organisation)

- 1946 – 34,000 employees
- 1975 – 90,000 employees in 89 countries
- 1970 – annual production of 220,000,000 pairs, annual sales of 300,000,000 pairs

1991 return to Czechoslovakia – establishment of the Baťa company with headquarters in Zlín was established



Picture (The Thomas Bata Foundation)

Tomas and Jan Bata and Competitive Business Strategies for Present Business World

Work

- 1895 – 50 employees
- 1931 – 29 500 employees
- 1894** footwear production
- 1903 precision engineering
- 1909 printing
- 1915 tannery **Bata**
- 1915 power station
- 1916 retail trade
- 1917 agriculture
- 1917 domestic shoe shops
- 1918 forestry
- 1918 brick manufacturing
- 1918 newspaper publishing
- 1919 woodworking plant
- 1919 shoe shops abroad
- 1919 company savings bank
- 1920 advertising
- 1923 shoe-repair shops
- 1924 rubber industry
- 1924 construction industry
- 1924 railway transport
- 1924 air transport
- 1925 construction projects
- 1926 chemical production
- 1926 paper processing
- 1926 lorry transport
- 1926 publishing house
- 1926 cinema
- 1927 film production
- 1927 food production
- 1928 chemical research
- 1929 pedicure
- 1930-32 tyre production
- 1930 insurance company
- 1931 textile production
- 1931 gas works
- 1932 coal mines
- 1932 hotel
- 1932 shipping



From Zlín into the World

- 1894 Zlín
- 1917-23 Pardubice
- 1929 Otrokovice
- 1930 Krasice
- 1931 Třebíč
- 1931 Bošany
- 1931 Nové Zámky
- 1917-32 network of approx. 1,800 shops CZ
- 1919-32 network of approx. 700 shops abroad (from Chicago to Singapore)
- 1921-32 network of affiliated companies abroad
- 1931 export of factories and architecture
- 1919-21 Lynn, USA
- 1931 Ottmuth, Germ.
- 1932 Borovo, Yugo.
- 1932 Chelmek, Pol.
- 1932 Möhlin, Switz.
- 1932 Hellocourt, Fr.
- Konagar, Tilbury

- 1910 canteen
- 1910-1920 supporting artists: Gahura, Kobzáň
- 1912 houses for employees
- 1918 company library
- 1918 company kindergarten
- 1918 improving education
- 1921 factory opened for excursions
- 1921 film screenings for employees
- 1921 company band
- 1924 health and social department
- 1924 SK Baťa sports club
- 1925, 1930 special education: shoemaking apprentice school (Baťa School of Work) secondary education
- 1925-29 public education reform (experimental schools in Zlín)
- 1926 employing the handicapped
- 1927 Baťa Hospital
- 1928 Baťa Relief Fund
- 1928 supporting science – Anthropos Brno
- 1930 specialised journals
- 1930 Shoe Museum
- 1930 zoological garden

10 S of Bat'a business system

| | Dimension | Realization |
|----|-----------------------|-----------------------------------|
| 1 | World class | Global benchmarking |
| 2 | Cooperation | Partnerships and alliances |
| 3 | Self-government | Private corporation |
| 4 | Participation | Profit sharing |
| 5 | Co-ownership | Employee capitalization |
| 6 | Self-management | Shop autonomy, internal markets |
| 7 | Co-entrepreneurship | Customer, internal and external |
| 8 | Competition | Internal benchmarking |
| 9 | Service to the public | Purpose of business |
| 10 | Synergy | Balanced system of all dimensions |

Bat'a Operational practices

- 1. The process of continuous innovation and improvement; the total system of preventive maintenance: machine shop working as “clockwork”;**
- 2. In-house adaptation and rebuilding of all purchased machinery; 10 percent of the engineering employees involved directly in the R&D function;**
- 3. The assurance of continuously high-quality output with processes streamlined to eliminate breakdowns and stoppages and individual workers given quality responsibility**

Bat'a Operational practices

4. **Total manufacturing flexibility was achieved by:**
 - **breaking the traditional large factory plant into smaller, semi-autonomous and specialized workshops; and**
 - **making all machines self-contained, independently powered and motorized by electric motors (referred to as “electric robots” by Bata)**
5. **Changes in product styles and types were achieved quickly (in a few hours) by rearranging machine sequences and layouts, by pulling out machines temporarily (“decoupling the line”) and by designing most adjustments and customization into the early stages of the production process;**
6. **A close personal “ownership” relationship between workers and “their” machines: not only was there no distrust of the machinery but there was also no neglect – only pride of ownership, emotional involvement and total care;**

Bat'a Operational practices

7. **All operators were able to stop production line conveyors at will; all waste in production was minimized (everything had to be ready just in time for the next step); all machines were designed to serve “the process,” not just individual operations;**
8. **Dedication to automation: one of Bata machines “did everything but talk and sing” (the note-scribbling overseas visitors were never able to copy it; a machine called the “Union press” produced a full pair of shoes in a single movement);**
9. **A perfect, semi-automated, rotational system of preventive maintenance of all machinery (including overhauls and updates), carried out without ever stopping production.**

DISRUPTION

Covid 19

Collapse of supply chains

Energy prices

War in Ukraine

Re-localisation

Lack of employees

Migration

Climate change



AI, AR, VR, blockchain



New materials and technologies



Loneliness, Irrelevance

Changes in the people's values



New business models – sales, service, sharing

Exponential and disruptive technologies



Innovation – repairing the world, by increasing value for customers and reducing waste

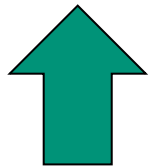

Increasing good and useful functions, benefits

Innovation =

Reducing harmful functions

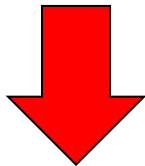
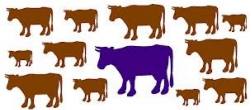

- Disruptive innovations
- Innovations improving business model
- Innovations improving life – social impact

Disruptive innovations



Incremental innovations



Social innovations

1. Inovato Cluster – networking, relationships, education

Digital platform for networking

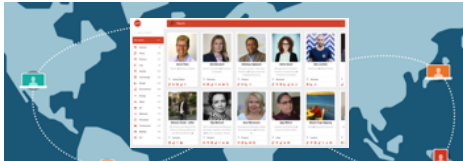

Live events, seminars, conferences



Workshops, Design Sprints with experts



2. Innovation projects, prototyping, testing functionality and market

Business model development



Prototype designing and testing



Project evaluation and selection



3. Venture Lab – seed starter, scale ups

Startups and pitch decks



Scale ups, investments



Knowledge development and sharing





We bring life to innovation

Innovation network



Rich world pandemic from 12% to 25 in EU

FIGURE 14. Loneliness in the EU

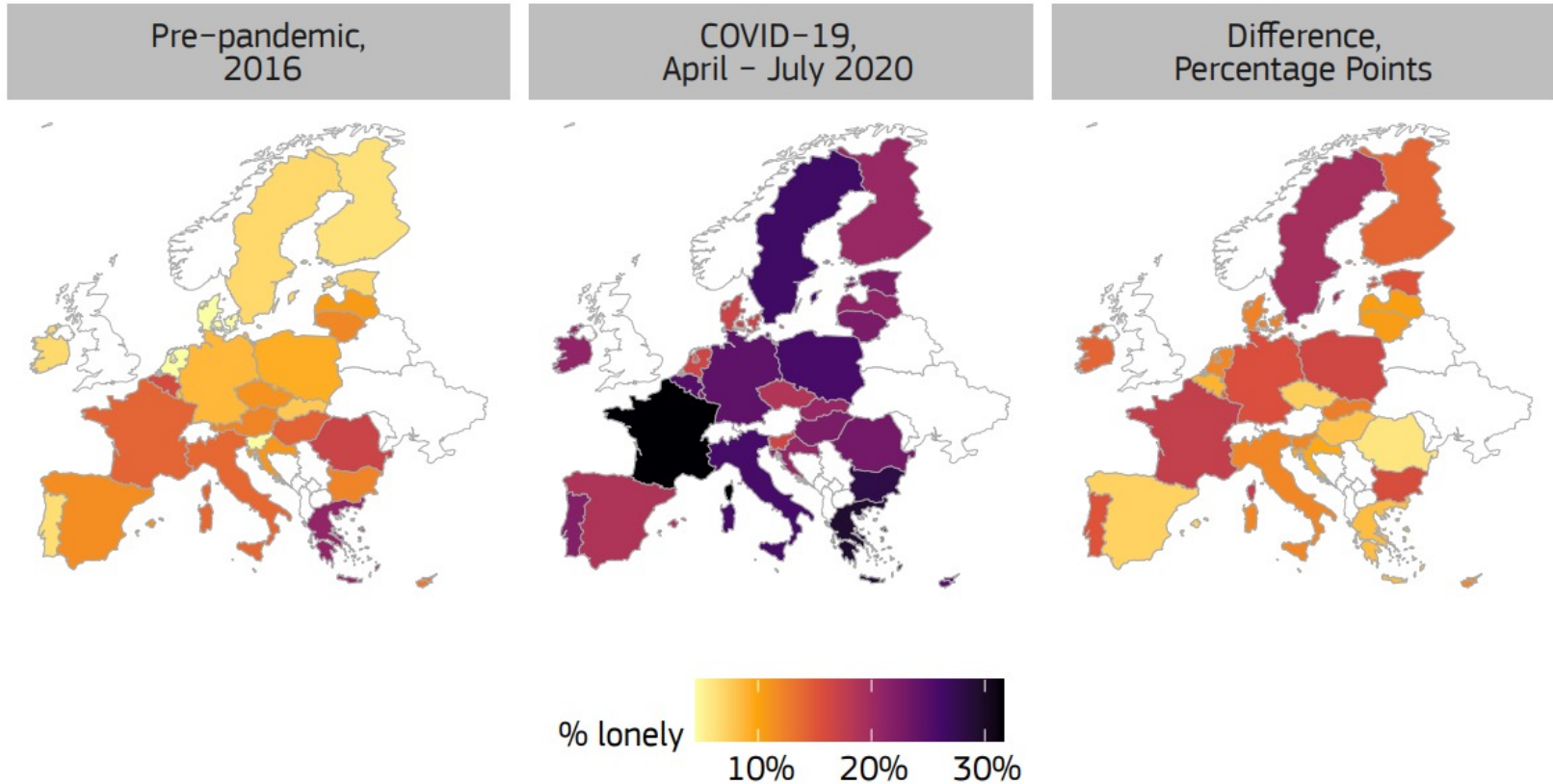

In the 20th Century, a relatively small elite exploited masses of people. The masses felt exploited but they were still very important. You could not run an economy without them.

In the 21st century, the main struggle will be about **irrelevance, many people are pushed aside. The elite don't exploit them. The elite don't need them. Most of the people are not being exploited; they are just **irrelevant**. It is much more difficult to fight against **irrelevance** than to fight against exploitation. The main problem is more psychological: "I am not important. I am humiliated..." Yuval Noah Harari**

Tomas and Jan Bata and Competitive Business Strategies for Present Business World

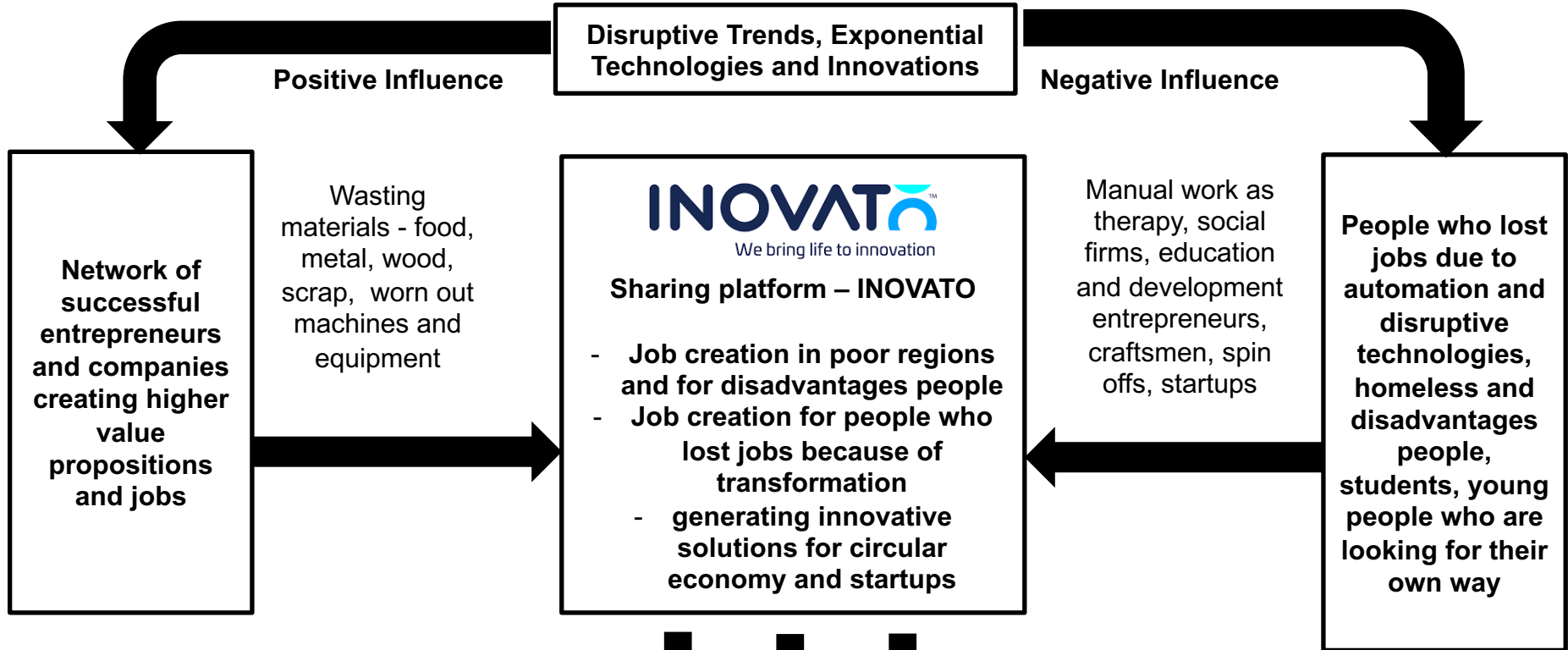

Reduction waste, generating jobs, creation knowledge, reduction of regional differences, business development in regions – re-localisation, circular economy, recycling, reduction of emissions



Good shepherd



We are using things which other people throw away

In the community Good Shepherd lives more than 750 people on the margine of society. There are old, poor and sick people, ex-homeless people, young people from children's homes, and people who had problems with alcohol, drugs and gambling in the past

Connecting the worlds - successful/“irrelevant”

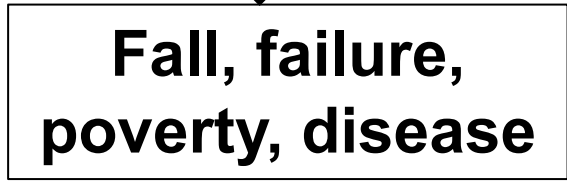
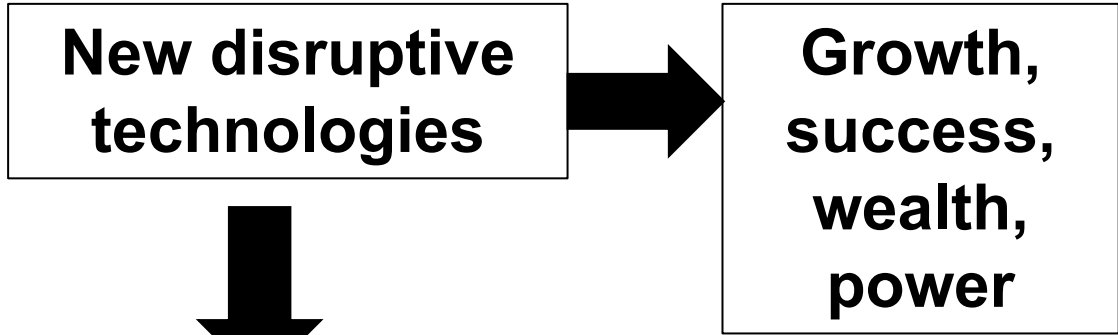

Surplus food, material, raw materials, waste, old machines, furniture, scrap

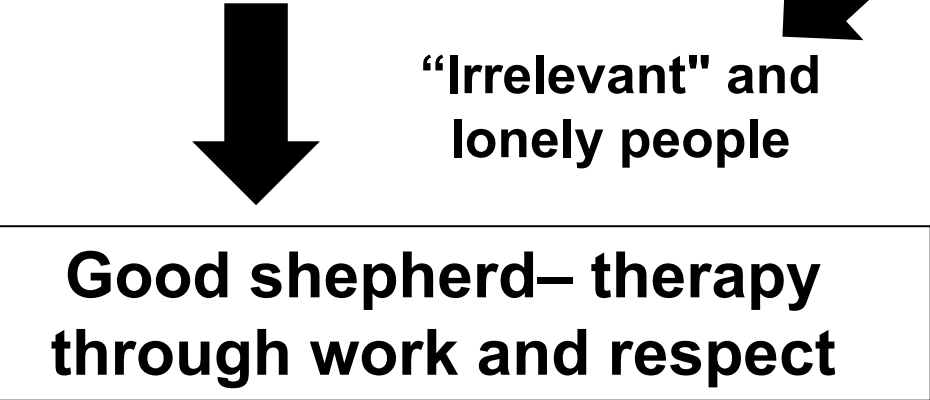

“If you want to build up a large company, first build up yourself.”

"There are 3 kinds of values you need in any job in the world: capital, knowledge and freedom."



4 dimensions and 4 roles in human development

Soul – mission, sense, give a legacy

Mind - learning and wisdom



Heart - relationships and cooperation



Body - health, performance, resilience antifragility

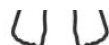

1. Me (we improve ourselves): Who am I? Where and how can I be useful and happy? So what do I have to do?

2. We (service to a close person): How can we complement each other? How to build relationships of trust? How to cooperate and achieve synergy?

3. Innovations (service to the company): How to turn problems into opportunities? How to add benefits and reduce waste and harmful functions?

4. We improve the world (service to society): How to change yourself and your surroundings for the better? How to improve the world for those who come after us?



Tomas and Jan Bat'a didn't export shoes, they exported industrial cities and factories

1. Customisation



2. Selfservice



3. Reduction of intermediates



10. Trust and cooperation



9. Sustainability



8. New generation of co-entrepreneurs

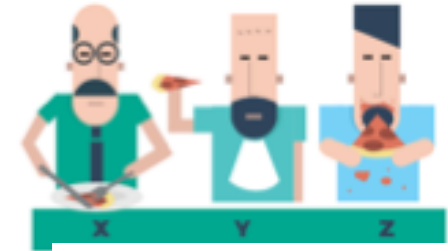

7. Sharing Economy, Networking



Transformation Trends and Modular Microfactory

4. Circular Economy



5. Disruptive Technologies



6. Digitalisation





We bring life to innovation

Innovation network

We would like to design, produce and export Advanced Modular Microfactories



Global
knowledge
and local
resources

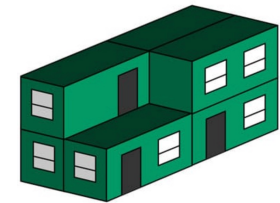
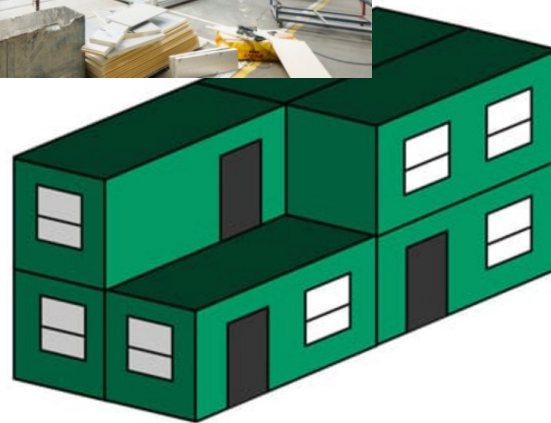



Advanced Modular Micro Factory

Defining functions (what does it do?) - functional structure

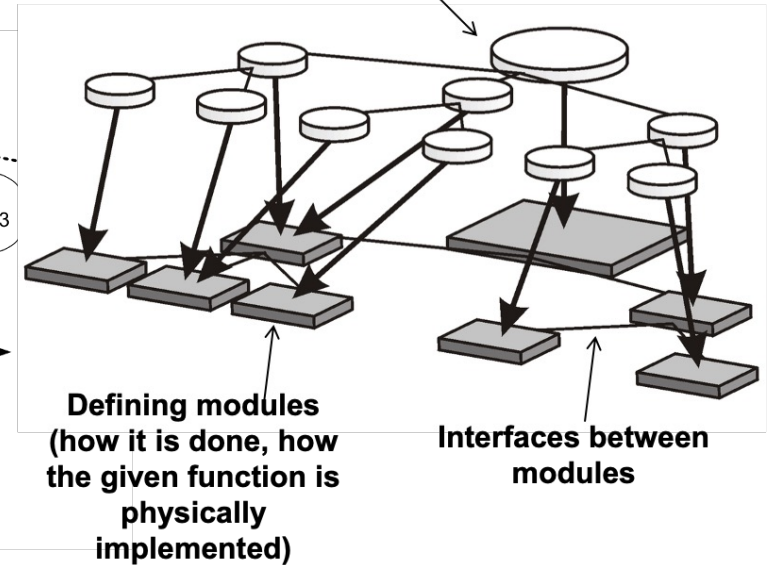
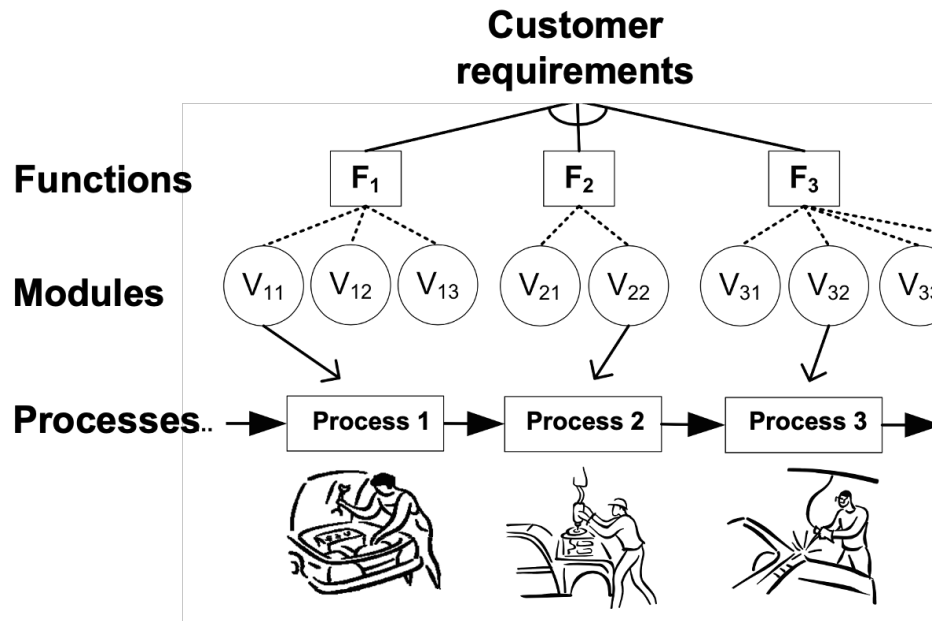

We will export Advanced Modular Microfactories

Modules

| | | |
|---|--|---|
| Machine  | Storage  | Robot  |
| Handling  | Inspection  | Control  |
| Assembly  | Manufacturing  | Monitoring  |
| Building  | Energy  | Air conditioning  |
| Lighting  | Water  | IoT  |

1. Design and planning – AR/VR and simulation



2. Production – digital twin



3. Installation and operation – virtual twin



Modular microfactory

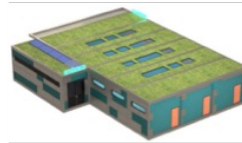

Desktop Factory for Assembly

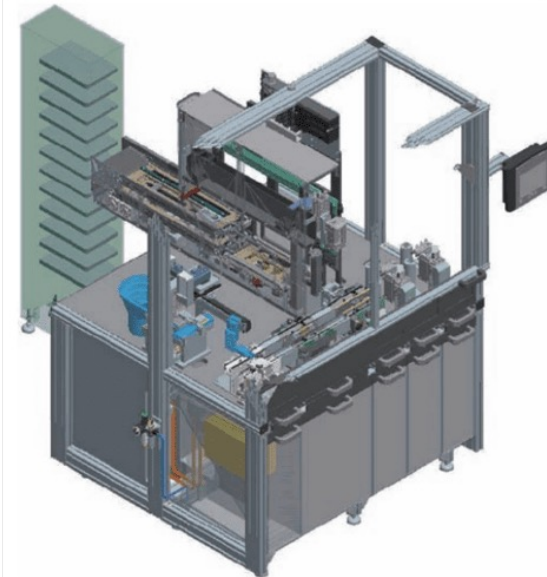

Standardized Modular Universal Manufacturing Platform by Bosch Rexroth AG



Traditional Factory vs. Modular Microfactory

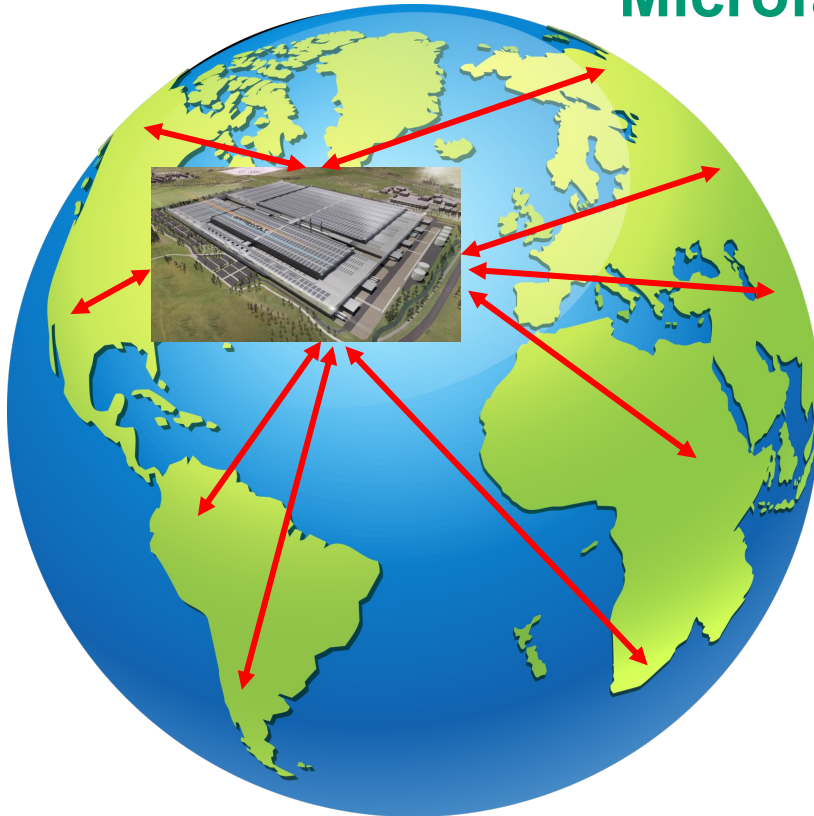

Huge carbon footprint, regional differences, complicated and expensive transportation and logistics



Carbon footprint reduction through modularity and re-location, elimination of regional differences and local economy

Modular Microfactory

Customer oriented
– customization and flexibility

Manufacturing as a service – mobility, capacity and knowledge sharing

Green and Sustainable – local and renewable energy sources, longer life cycles of the building and equipment, recyclability and remanufacturing

Social – local economy



Availability for startups, spinoffs and poor countries – growing with the customers and rent services

Efficient– lean processes, digitalisation, smart automation, remote control

Customer oriented – customization, reconfigurability and flexibility

Safe – ergonomics and human centred design

Kinazo design – first 3D printed modular eBike (concept of customized flexible modular factory)

<https://kinazo-design.com/e-bike/>



ajkolejšíci clovek na planete / Žužicka



prezentacia na Udrzbe / priatel Peter



navrh dizajnu prezentacneho panelu kinazo eBike



vyber materialu IKEA detail uchytu kola

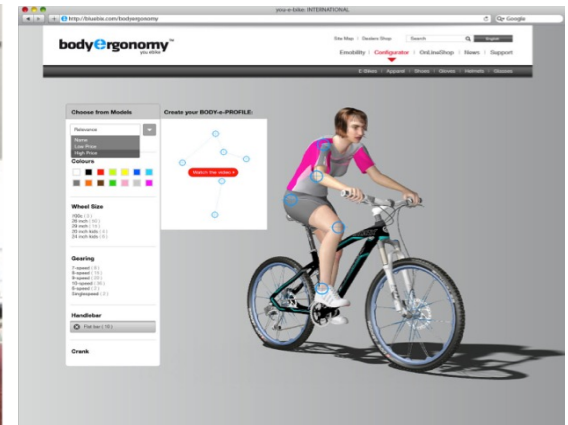

pocas vyroby prezentacneho panelu
torovne stih videa / Slavo, Adam a Jano
Bratislava 25 April 2017



finalizacia stavby panelu / Zilina 26 Apr 2017
cas rakcie 1h : 17 min



Janko Kosturik prezentuje Dielo ucastrskom konferencie
Zilina 26 Apr 2017 / 8:30



posledne detaily
uchytienia kola



finalny panel
Zilina 26 Apr 2017
cas rakcie 1h : 17 min



Linka prikada rulu k Dielu a bavi ju to :)

Finalizacia panelu v predajni RDE
Banoka Bystrica / 27 Apr 2017 / 16:50



Kinazo design

Kinazo e1

KOMA + Inovato project – modular product (condensing unit), digital configurator, modular factory

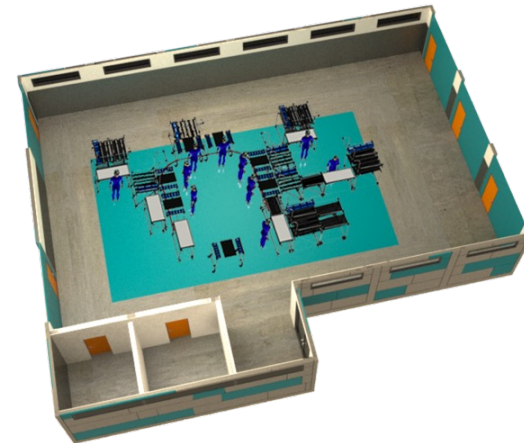
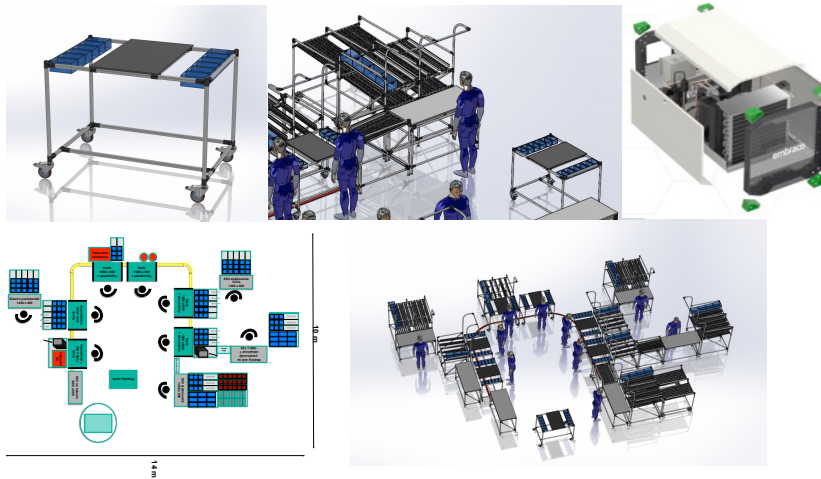
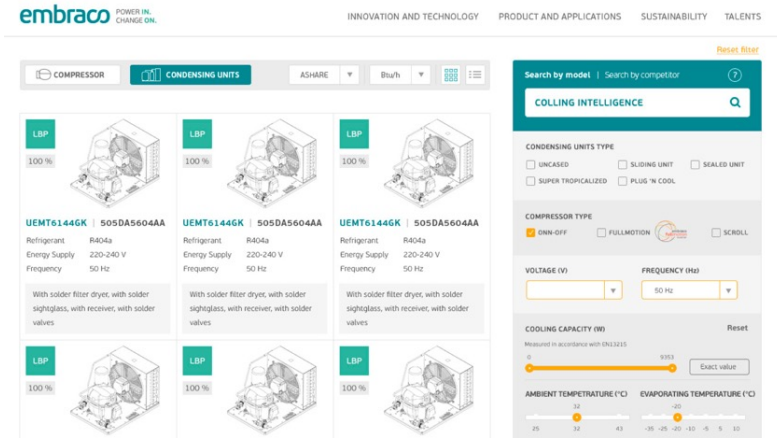
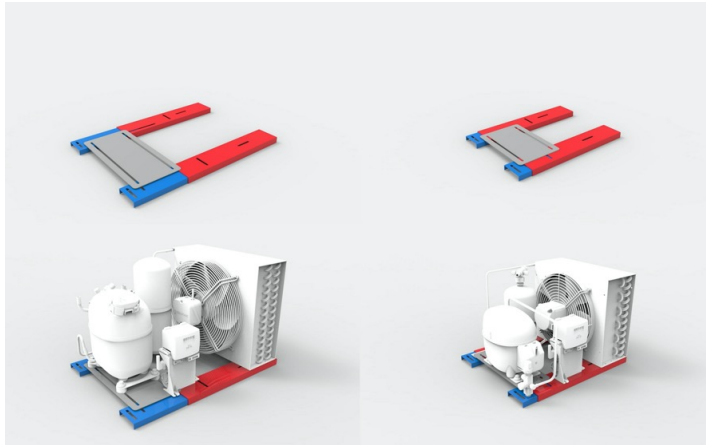



We will export
Advanced
Modular
Microfactories
for local
manufacturing with
global
knowledge

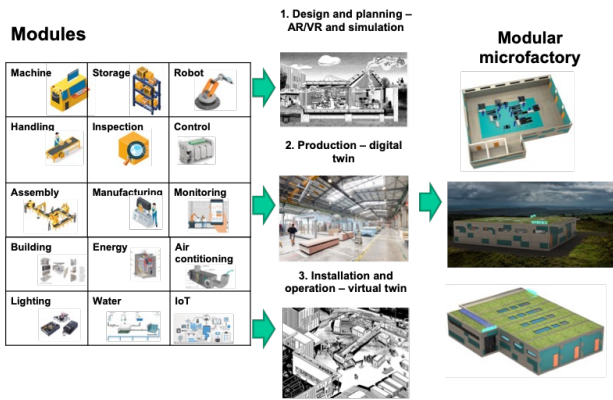

Desktop Factory for Assembly

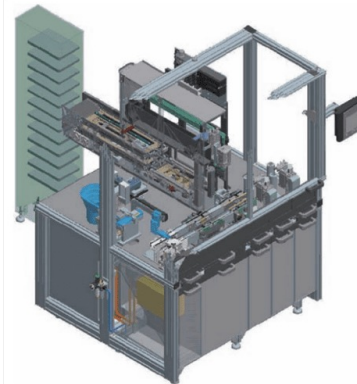

Standardized Modular Universal Manufacturing Platform by Bosch Rexroth AG



„Do not pursue money. He who pursues money will never achieve it. Serve! If you serve as best as you can, you will not be able to escape money.“

